

8 Way Compact Cassette 208~230V



Job Name: _____ Date: _____

System Reference No.: _____ Engineer Signature: _____

Model: GMV-ND09T/E-T(U)



Specifications	Unit	Parameter
Performance		GMV-ND09T/E-T(U)
Rated Cooling Capacity	kBtu/h	9.5
Rated Heating Capacity	kBtu/h	10.5
Sound Pressure Level (H/M/L)	dB(A)	36/33/28
Electrical Data		
Power supply	Voltage, Phase, Hertz	208/230, 1, 60
Minimum Circuit Amps (MCA)	A	0.7
Maximum Overcurrent Protection (MOP)	A	15
Fuse	A	15
Fan		
Type x Quantity		Centrifugal x 1
Air Flow Volume (H/M/L)	CFM	335/280/250
Fan Motor Running Current	A	0.3
Fan Motor Power Input	W	35
Refrigerant Piping		
Connection Pipe	Gas (inch)	3/8
	Liquid (inch)	1/4
Connection Method		Flare Connection
Refrigerant		R410A
Cassette Dimension/Weight		
Dimensions (WxDxH)	inch	22-7/16 x 22-7/16 x 10-7/16
Net Weight	lbs	38.6
Panel Dimension/Weight		
Panel model		TF05
Dimensions (WxDxH)	inch	24-3/8 x 24-3/8 x 1-7/8
Net Weight	lbs	6.6
Other		
Safety Certification		ETL

Outline and Physical Dimensions of GMV-ND09T/E-T(U).

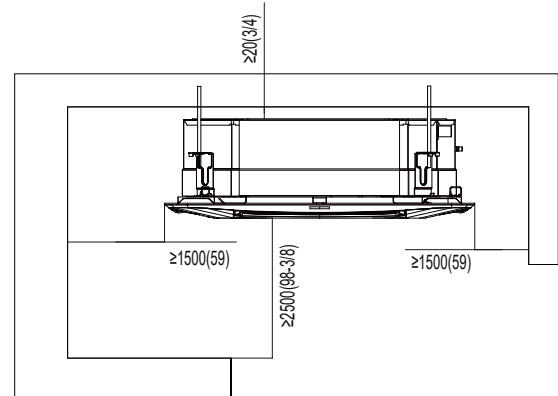
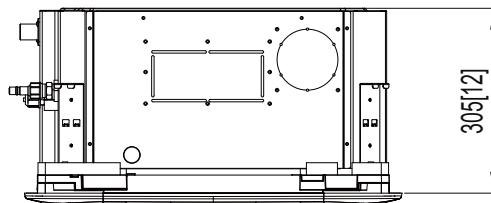
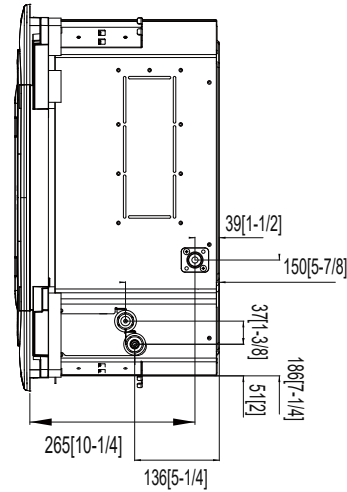
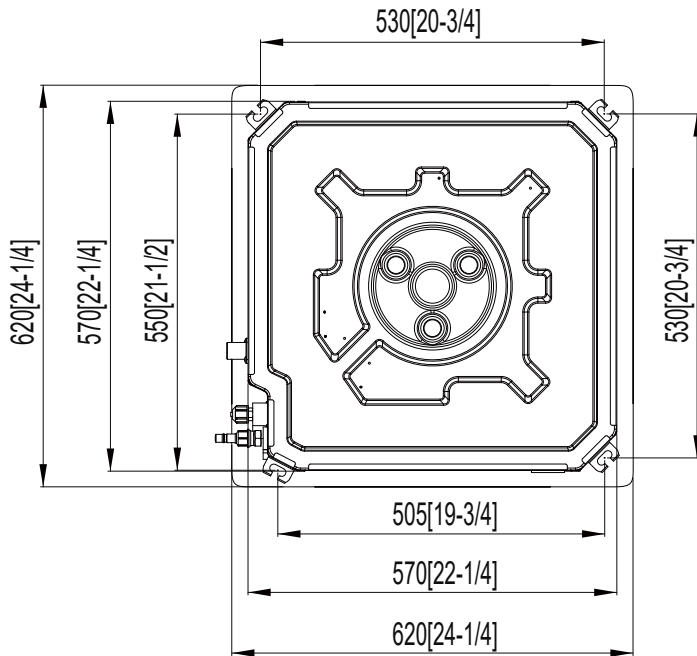

Unit:mm(in.)

